

Principles of robot locomotion

Sven Böttcher

Seminar

‘Human robot interaction’

Index of contents

1. Introduction.....	1
2. Legged Locomotion.....	2
2.1 Stability.....	3
2.2 Leg configuration.....	4
2.3 One leg.....	5
2.4 Two legs.....	7
2.5 Four legs.....	9
2.6 Six legs.....	11
3 Wheeled Locomotion.....	13
3.1 Wheel types.....	13
3.2 Issues of wheeled locomotion.....	15
3.3 Examples of wheel configurations.....	16
4 Other concepts.....	19
4.1 Tracked slip/skid locomotion.....	19
4.2 Walking wheels.....	20
Conclusion.....	20
References.....	22

1. Introduction

A mobile robot needs locomotion mechanisms to make it enable to move through its environment. There are several mechanisms to accomplish this aim; for example one, four, and six legged locomotion and many configurations of wheeled locomotion. The focus of this elaboration is legged and wheeled locomotion.

Legged robot locomotion mechanisms are often inspired by biological systems, which are very successful in moving through a wide area of harsh environments. Figure 1 shows some locomotion mechanisms found in nature, of course there are many more, for example the six legged walking of a stick insect, which is often a paradigm for six legged robots. But it is very difficult to copy these mechanisms for several reasons. The main problems are the mechanical complexity of legs, stability and power consumption. Chapter 2 shows several leg configuration and these problems more in depth.

On the other hand there is wheeled locomotion. Wheels are a human invention and a very popular locomotion concept in man made vehicles. Chapter 3 shows the reasons for this and furthermore some kinds of wheels and different wheel configurations.

On the first view there is no inspiration in the nature for a wheel, but the human bipedal walking can be approximated as a rolling polygon with sides equal in length d to the span of the step, as figure 2 shows. Decreasing the step size means, that the polygon approaches a wheel, of course there is no actively powered wheel, which is needed for wheeled locomotion, in the nature.









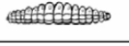
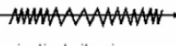

Type of motion	Resistance to motion	Basic kinematics of motion
Flow in a Channel 	Hydrodynamic forces	Eddies 
Crawl 	Friction forces	Longitudinal vibration 
Sliding 	Friction forces	Transverse vibration 
Running 	Loss of kinetic energy	Oscillatory movement of a multi-link pendulum 
Jumping 	Loss of kinetic energy	Oscillatory movement of a multi-link pendulum 
Walking 	Gravitational forces	Rolling of a polygon (see figure 2.2) 

Figure 1: Locomotion mechanisms found in nature [1]

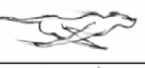
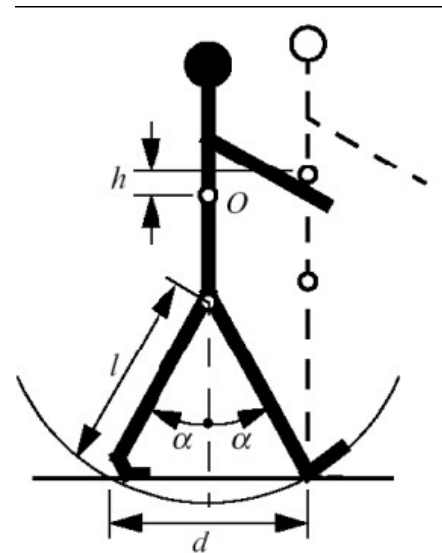

Figure 2: Approximation of the Human walking by rolling polygon [1]

Most mobile robots are legged or wheeled, but there are some other locomotion concepts, as chapter four shows. For each locomotion concept, doesn't matter if it is wheeled, legged or a different concept, there are three core issues: stability, the characteristics of ground contact and the type of environment, as described in [1].

The main attributes of stability are the number and geometry of contact points, the robot's centre of gravity, if the robot is static or dynamic stable and the inclination of terrain.

The characteristics of ground contact depend on the type of the contact point (in case of legged locomotion this is the footprint), the angle of contact to the ground and the friction between the robot and the surface.

The attributes of the type of the environment are the structure of the medium (for example in case of hard ground, if the ground is either flat or rough) and the medium itself (e.g. water, air, hard or soft ground).

These issues are considered especially in the following two chapters when different locomotion concepts are introduced.

2. Legged Locomotion

A legged robot is well suited for rough terrain; it is able to climb steps, to cross gaps which are as large as its stride and to walk on extremely rough terrain where, due to ground irregularities, the use of wheels would not be feasible. To make a legged robot mobile each leg must have at least two degrees of freedom (DOF). For each DOF one joint is needed, which is usually powered by one servo. Because of this a four legged robot needs at least eight servos to travel around. Figure 3 shows the energy consumption of different locomotion concepts. It strikes that the power consumption of legged locomotion is nearly two orders of magnitude more inefficient than of wheeled locomotion on hard, flat surface (e.g. railway wheel on steel). One reason for this is that wheeled locomotion requires in general fewer motors than legged locomotion.

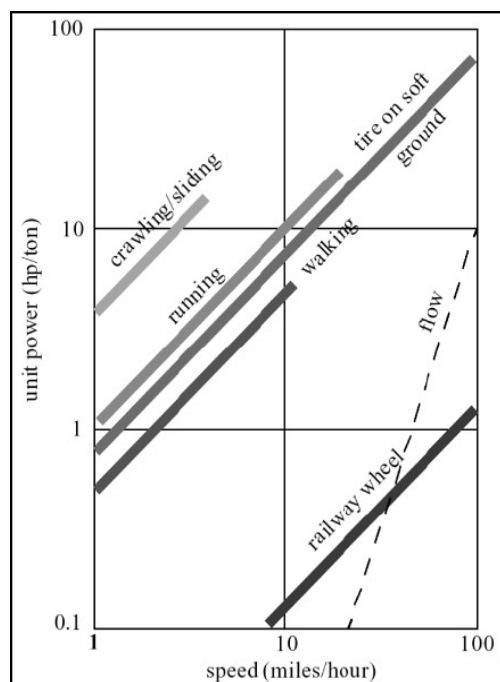

Figure 3: Power consumption of several locomotion [1] mechanisms

When the surface becomes soft wheeled locomotion offers some inefficiency, due to increasing rolling friction more motor power is required to move. As figure 3 shows legged locomotion is more power efficient on soft ground than wheeled locomotion, because legged locomotion consists only of point contacts with the ground and the leg is moved through the air. This means that only a single set of point contacts is required, so the quality of the ground does not matter, as long as the robot is able to handle the ground. But exactly the single set of point contacts offers one of the most complex problem in legged locomotion, the stability problem.

2.1 Stability

Stability is of course a very important issue of a robot, because it should not overturn. Stability can be divided into the static and dynamic stability criterion.

Static stability means that the robot is stable, with no need of motion at every moment of time. Static stability is explained by an easy example: Figure 4 shows a stool with three legs. Balance is maintained as long as the centre of mass is completely within the red triangle, which is set by the stools' footprints. This triangle is called *support polygon*. The support polygon is the convex hull which is set by the ground contact points. Of course, in case of more ground contact points, the polygon can be a quadrangle or a pentagon or a different geometrical figure. More in general the following must hold to support static stability: *Static stability is given, when the centre of mass is completely within the support polygon and the polygon's area is greater than zero*, therefore static stability requires at least three points of ground contact [1].

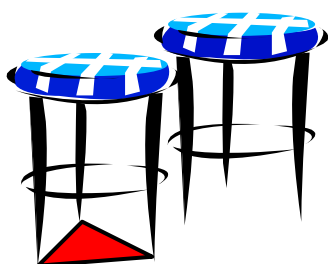

Figure 4 a): Example of a stool

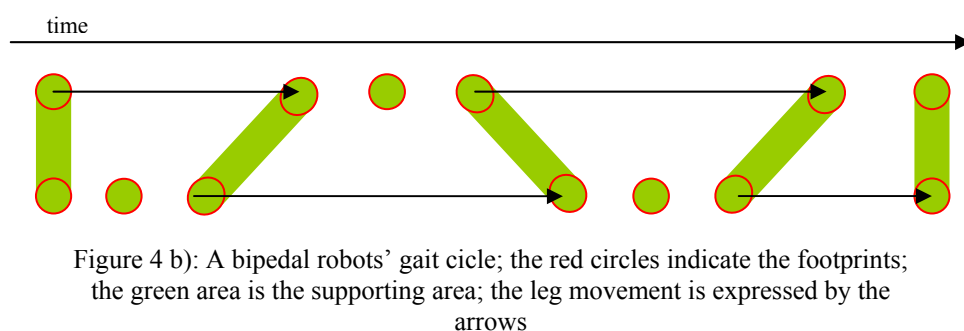

Figure 4 b): A bipedal robots' gait cycle; the red circles indicate the footprints; the green area is the supporting area; the leg movement is expressed by the arrows

To achieve statically stable walking a robot must have a minimum number of four legs, because during walking at least one leg is in the air. Statically stable walking means that all robots' motion can be stopped at every moment in the gait cycle without overturning. Most robots which are able to walk static stable have six legs, because walking static stable with four legs means that just one leg can be lifted at the same time (lifting more legs will reduce the support polygon to a line), so walking becomes slowly [2].

Most two legged walking machines are *dynamically stable* for several reasons.

Human like robots have relatively small footprints, because of this the support polygon is almost a line (in the double support phase, when both foos are connected with the ground) which is even reduced to a single point (in the single support phase, when just one foot has ground contact) during walking.

Therefore the robot must actively balance itself to prevent overturning. Figure 4 b) shows the changing support polygon in a bipedal walking machines' gait cycle. In face of that the robots' centre of mass has to be shifted actively between the footprints. But the robots exact centre of mass is hard to predict due to the high dynamic of walking (for example because of the force which is imparted to whole robot when one leg swings forward) [3].

The realization of bipedal dynamic stable walking machines is due to the continuous danger of overbalance a high complex problem for engineers, which is just solved for some special cases. One Approach to solve this problem is explained in chapter 2.4.

2.2 Leg configuration

To move a leg forward at least two degrees of freedom are required, one for lifting and one for swinging. Most legs have three degrees of freedom; this makes the robot able to travel in rougher terrain and to do more complex manoeuvres. Figure 5 shows the leg of the Titan VIII robot from the Tokyo Institute of Technology. This leg has three degrees of freedom. In general, adding degrees of freedom to a robots leg means increasing the manoeuvrability of the robot, the range of terrain on which it can travel and the ability to travel in a variety of gaits.

But adding degrees of freedom causes also some disadvantages, because for moving additional joints and more servos are required, this increases the power consumption and the weight of the robot. Furthermore controlling the robot becomes more complex, because more motors have to be controlled and actuated at the same time.



Figure 5: Leg of Titan VIII [1]

If the robot has more than one leg there is the issue of leg coordination for locomotion. The total number of possible gaits in which a robot can travel depends on the number on legs it has. The gait is a periodic sequence of lift and release events for each leg. If a robot has k legs the number of possible events N is, accordant to [1],

$$N=(2k-1)!$$

In case of a bipedal walking machine ($k=2$) the number of possible events is

$$N=(2k-1)! = (2*2-1)! = 3! = 6$$

So there are six possible different events, these are

1. Lift left leg
2. Release left leg
3. Lift right leg
4. Release right leg
5. Lift both legs together
6. Release both legs together

In case of $k=6$ legs there are already 39916800 possible events, in face of that, controlling a six legged robot is because of the large number of possible events more complex than controlling a two legged robot. But robots with fewer legs have some other problems; one of the most complex problems is stability as mentioned before. In the following different leg configurations, advantages/disadvantages of these and examples of robots are shown.

2.3 One leg

One leg is of course the minimum number of legs which a legged robot can have. A smaller number of legs reduces body mass of the robot and no leg coordination is needed. One-legged locomotion requires just a single point of ground contact; this makes the robot amenable to travel the roughest terrain. As an example the robot is able to overcome an obstacle like a gap that is larger than its stride by talking a running start. A multi legged robot that can not run is just able to cross gaps that are as large as its reach. But the single point of ground contact offers the main problem for single legged robots – stability. Static stability is impossible even when the robot is stationary, because the support polygon is reduced to a single point. So singled legged robots must be dynamically stable, that means that the robot has to actively balance itself either by changing its centre of gravity or by imparting corrective forces. One of

the first successful one-legged robots was the one leg hopper (Figure 6) from the MIT, developed by Marc Raibert in 1983 [4].

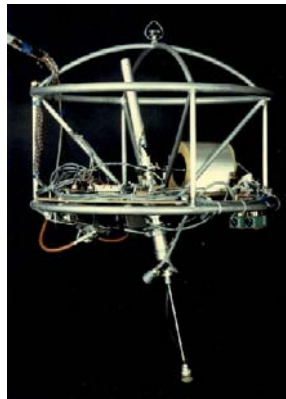

Figure 6: One leg hopper [5]

Raibert's hopper is not able to be stable when it is stationary, so it has to hop all the time. To support locomotion and stability there is of course the need of controlling the robot. Raiberts' hopper uses a simple controller, which divides the control problem into three independent parts. These parts are hopping height, velocity and attitude. [4]

- Hopping height: The control system controls hopping height by manipulating hopping energy. The leg is springy, so hopping is a bouncing motion that is generated by an actuator (an external air-pressure pump) that excites the leg. Hopping height is determined by the energy recovered from the previous hop, the losses in the hopping cycle and thrust developed in the actuator. Height is regulated by adjusting the amount of thrust on each cycle to just make up for losses.
- Velocity: The control system manipulates forward velocity by placing the foot with respect to the centre of the CG-print on each step. The CG-print is the locus of points on the ground over which the centre of gravity of the system will pass during stance. Displacing the foot from the centre of the CG-print causes the system to run either faster or slower. The control system calculates the length of the CG-print from the measured forward velocity and an estimate of the duration of stance. The error in forward velocity determines a foot position that will maintain the correct speed of forward travel.
- Attitude: The control system maintains an erect body posture during running, by generating hip torques during stance that servo the body angle. During stance friction between the foot and ground permits large torques to be applied to the body without causing large accelerations of the leg. These torques are used to implement a simple proportional servo that moves the body toward an erect posture once each step.

2.4 Two legs

Bipedal walking robots have become very popular in the last ten years; two of the most well known examples are QRIO from Sony (Figure 7) [5] and Asimo from Honda (Figure 8) [6]. Qrio has a weight of 7 kg and a height of 58 cm, each leg has six degrees of freedom; Asimo has a weight of 210 kg, a height of 1.82 cm and a maximum walking speed of 2 km/h, each leg has six degrees of freedom.



Figure 7: QRIO (Sony) [6]



Figure 8: Asimo (Honda) [20]

Two legged robots are already able to walk, run, jump, dance and travel up and down stairs, but stability is still a problem for bipedal robots, because they have to be dynamically stable. There is no general algorithm to solve the problem of dynamic stability for bipedal robots; often used approaches are based on the zero moment point (ZMP). Examples of robots using this approach are QRIO and Asimo [5,6]. The rudiment idea of this approach is to maintain balance by planning footprint positioning. The ZMP is the point where the robot has to base on to keep its balance. When the robot should move forward it has first to compute the ZMP and after that it has to step the appropriate leg exactly to the computed position. The *Zero Moment Point*¹ (ZMP) is often described in robotics as the point on the ground where all momentums are equal to zero. The ZMP can be computed with equation (1) and (2) (accordant to [8]):

$$(1) \quad x_{ZMP} = \frac{\sum_i m_i (z + g) x_i - \sum_i m_i x z_i - \sum_i I_{iy} \theta_{iy}}{\sum_i m_i (z + g)}$$

$$(2) \quad y_{ZMP} = \frac{\sum_i m_i (z + g) y_i - \sum_i m_i y z_i - \sum_i I_{ix} \theta_{ix}}{\sum_i m_i (z + g)}$$

¹ The Zero Moment Point was introduced by Miomir Vukobratović et al. in 1972, it has been interpreted in many ways, one example of this, is the definition of Huang et al., as shown in equation (1) and (2) [8]. More information about the Zero Moment Point can be taken from [7].

where $(x_{ZMP}, y_{ZMP}, 0)$ are the ZMP coordinates in the Cartesian coordinate system, (x_i, y_i, z_i) is the mass centre of the link i , m_i is the mass of the link i , and g is the gravitational acceleration.

I_x and I_y are the inertia moment components, θ_{ix} and θ_{iy} are the angular velocity around the axes x and y (taken as a point from the mass centre of the link i). Figure 9 shows an example of a robot's mass distribution.

To support stability the ZMP has to be completely within the support polygon. If one leg is in the air, the support polygon is equal to the shape of the foot which is connected with the ground, so the ZMP has to be completely within the footprint to support stability. If both feet are connected with the ground the ZMP can be within the area which is built by the two footprints.

Asimo and QRIO are robots which are already able to walk freely through their environment, but they have to take care of their balance at every time. Spring Flamingo (Figure 10) [9] is a robot which was developed at the MIT in 1996 to 2000 by Jerry Pratt. Each leg of Spring Flamingo, which is inspired by a flamingo, has three degrees of freedom, these are realized by a hip, knee and ankle joint.

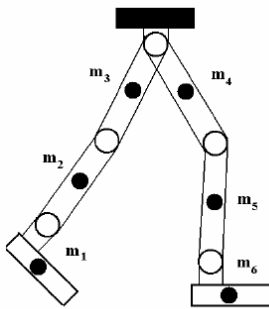

Figure 9: Example of a robot's mass distribution [8]



Figure 10: Spring Flamingo (MIT) [9]

In addition each leg has a kneecap that limits the knee joint angle. Spring Flamingo's research goal is not to solve the stability problem, because it is held by a bar at every moment of movement, as figure 10 shows, so it is not able to overturn. Due to this the stability problem is suppressed and the focus of research is on developing various walking algorithms, motion description and control techniques and force control actuation techniques.

One benefit of a two legged locomotion is that the total weight of the robot is reduced due to fewer legs (a six legged robot has much more leg mass and because of this more body mass), but this advantage creates another problem. Each leg must have sufficient capacity to support the full weight of the robot, in case of four or six legged robots the weight of the robot's body is distributed to more legs.

An important feature of bipedal robots is their anthropomorphic shape, they can be build in human like dimensions, which makes them predestinated for research in human robot interaction.

2.5 Four legs

One of the most famous four legged robot is Sony's Aibo (figure 11) [10]. Some of Aibo's most interesting features are a stereo microphone, which enables it to pick up surrounding sounds, a head sensor to notice a person who tabs its head, eye lights (these light up in blue, green or red) to indicate Aibo's emotional state, a colour camera to search for objects and recognize them by colour and movement, and speakers to emit sounds. Some four legged robots are also well adapted for research in human robot interaction, if they have an animal shape (like Aibo). Humans can treat them as a pet and might develop an emotional relationship to them.

Another example of a quadruped robot is Titan VIII (figure 12) [1], which was developed at Tokyo Institute of Technology. Titan VIII has a weight of 9 kg, a height of 0.25 m and each leg has six degrees of freedom.

Most four legged robots use dynamic stable walking (like nearly all four legged animals), because static stable walking requires at least three points of ground contact. This means that just one leg can be lifted at the same time and so walking becomes slowly; in case of dynamic stability the number of ground contact points can vary from zero, when the robot is jumping, to the total number of legs, when the robot is stationary. One possible dynamic stable gait of Titan VIII is a trot gait, where the two diagonal legs are lifted at the same time.



Figure 11: Aibo (Sony) [10]

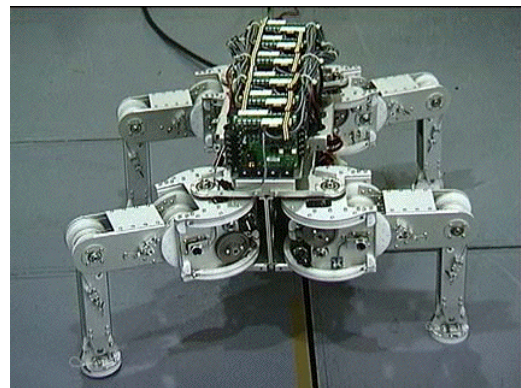

Figure 12: Titan VIII (Tokyo Institute of Technology) [1]

Titan VIII's dynamic stable walking is also based on the ZMP. To support stability during walking the ZMP has to be about the diagonal line, which is set by the two legs with ground contact. More information about realization of this concept can be taken from [16].

As mentioned before four legged robots are able to walk statically stable. Figure 13 a) shows a simplified model (2D+1 Model) [11] of a four legged robot. The body of the robot is described by a polygon, the

legs by straight lines and the footprints by empty or filled circles (empty if the leg is raised, filled if the leg has ground contact). The centre of the polygon is considered as the robots centre of mass, indicated by the green point (this is of course a simplified assumption). The number one to five indicates a predefined set of leg position. That means that each leg can take one of these positions and it can be raised or set down.

The total number of possible robot configurations is equal to $5^4 \times 2^4 = 10000$, but not all of these configurations are stable. Figure 13 b) shows an example of a stable configuration and Figure 14 c) shows an unstable one (the red triangle is the support polygon).

One way to find static stable gaits can be done by first reducing the total number of configurations, by eliminating all those configurations which are unstable (for example by testing all configurations). After that a search in the set formed by the stable robot configuration can be done, to find sequences of configurations, which can be used as gaits. An algorithm to find those sequences is described in [11].

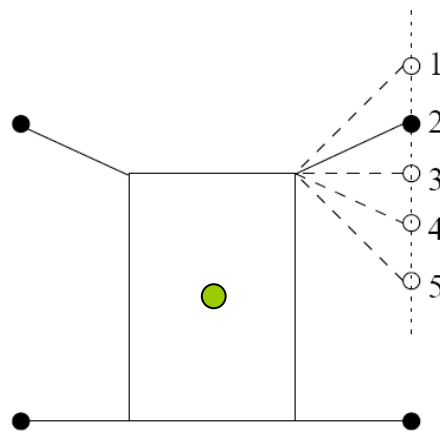

Figure 13 a): s2D+1 Model of a four Legged robot

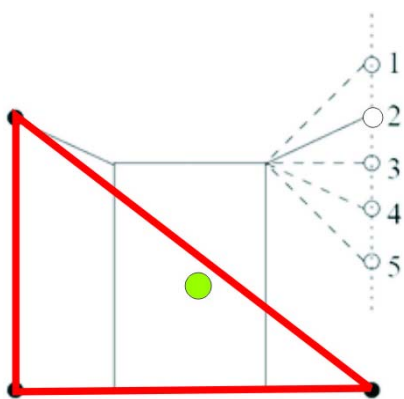

Figure 13 b): stable configuration

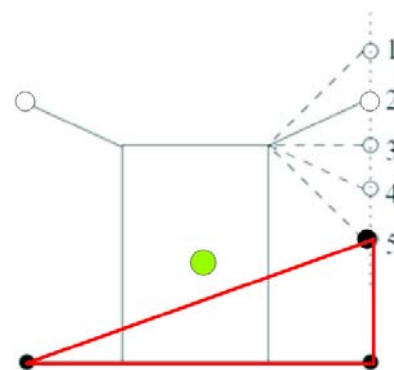

Figure 14 c): unstable configuration

2.6 Six legs

Six legged locomotion is the most popular legged locomotion concept because of the ability of static stable walking. The most used static stable gait is the tripod gait, where each times the two exterior legs on the one side and the inner leg of the other side are moved together. Due to the possibility of static stable gaits the control complexity is reduced on the one hand, because there is no issue of stability control in general, but on the other hand most six legged robots legs have three degrees of freedom and six legs have to be controlled, so leg coordination becomes more complex. Six legged robots are often inspired by nature, two examples of such robots are Lauron (figure 14) and Genghis (figure 15).

One approach to reduce the complexity of controlling is to decentralize the control of the robot. Studies of the nervous system of six legged animals have shown that most six legged animals control their leg movement locally and not by brain [2]. An often used example for six legged robots is the stick insect.

Lauron III (Figure 14) is an example of a six legged robot which is inspired it. The Lauron project began in 1993, Lauron III is the current robot which was developed in 2001 and is still advanced by the Forschungszentrum Informatik, group IDS in Karlsruhe. Lauron III has a length of 0.5 meter, a height of 0.3 meter, width of 0.8 meter, a weight of 18 kg and each leg has three degrees of freedom. Each leg is controlled by one Siemens 80C176 microcontroller, all legs are connected among each other and with an onboard PC/104 (equipped with a Pentium II 400 and a Real Time Linux) by a CAN-Bus [12].

The control software of Lauron III is built (like the hardware architecture) hierarchically. The software is divided into modules for different subtask and is distributed to the microcontrollers and the PC/104. These different modules are a joint controller for each joint (gets as input an angle and sets the joint accordant to the angle), a leg controller for each leg (routes angles to the joint controllers to set the footprint to a defined position) and a gait controller (coordinates the legs). Dividing the complex overall control system into smaller subsystems makes developing the overall system easier and more understandable. Another advantage is that subsystems can be developed and tested independently without changing the whole system.

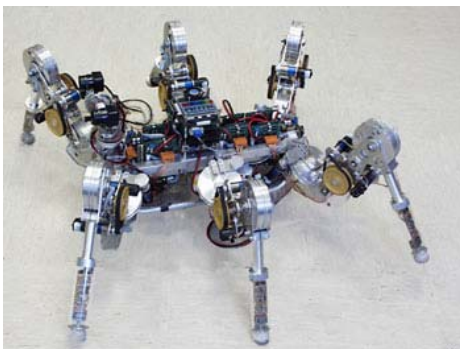

Figure 14: Lauron (Forschungszentrum Informatik, group IDS in Karlsruhe) [12]



Figure 15: Genghis (MIT) [5]

The problem of “how to make a legged robot walking” can be solved by programming the robot as finite automata, where all walking actions are defined before walking through the environment. The main disadvantage of this approach is that the robot has to be programmed new, when the environment changes, so the robot is not able to walk through a dynamic changing environment. Another approach is the use of reinforcement learning algorithms, by mean of these the robot is able to learn walking by it self. The object of reinforcement learning is to learn something by trial and error interaction with a dynamic environment. The subject who wants to learn something is called the agent (in this case it is of course the robot). In the standard reinforcement learning model (Figure 16) the agent is connected to the environment via perception and interaction. The agent receives at discrete points of time $t = 0, 1, 2, \dots$ the state of the environment s_t as input. Then the agent chooses an action a_t of possible set of actions $A(s_t)$ as output and the environment changes into a new state s_{t+1} . To optimize the agents behaviour, the agent gets a reinforcement signal $r_{t+1} \in R$ after each action. R is the set of reinforcement signals, for example $R = \{0, 1\}$, where 0 is a penalty and 1 a reward. These signals indicate the agent, when it comes into a known situation, if the decision taken the last time was good or not, so it can take the same action as the last time or it can try a different one. The goal of reinforcement learning algorithms is to choose actions that increase the long-run sum of values of the reinforcement signals. In this way the agent will learn to act in the environment [13].

In case of a legged robot the robot is the agent, the environment is the environment where the robot should walk through and input (including reinforcement signals) is committed with sensor (e.g. camera, touch sensor, etc). Reward can be given when the robot has moved and penalty can be given when the robot has crashed.

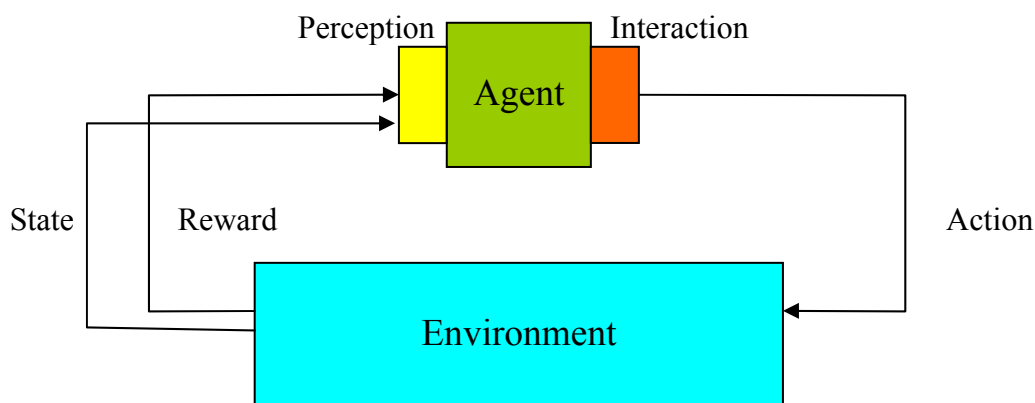

Figure 16: Reinforcement learning model

An example of a six legged robot which is able to learn walking with a reinforcement learning algorithm is Genghis (Figure 15), developed by Rodney A. Brooks at the MIT. The learning algorithm was developed by Pattie Maes and Rodney A. Brooks in 1990 [14]. Genghis is able to learn coordinating its legs to move forward. Each leg of Genghis has two elemental behaviours, swing-leg-forward and swing-leg-backward (that means that the elementary leg movement is given and has not to be learned); learning means in this case that the right behaviour has to become active in the right moment to move forward. To

achieve this aim a statistical method is used, that calculates in which state and how often an action ends in a positive (when Genghis moves forward) or negative result (when Genghis crash). Negative feedback is committed by two touch sensors (figure 17) at the bottom of Genghis; these are activated, when one or both sensors have ground contact, in case when Genghis overturns. Positive feedback is committed every time when a trailing wheel (figure 17) behind Genghis measures forward movement. In this way Genghis is able to adopt a static stable gait like the tripod gait [14].

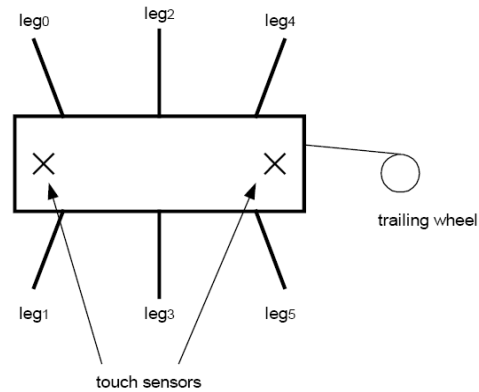

Figure 17: Schematic representation of Genghis' sensors [14]

3 Wheeled Locomotion

The most popular locomotion mechanism in man made vehicles is wheeled locomotion; so it is not surprising that it is often used in mobile robotics. Reasons for this are the easy mechanical implementation of the wheel, there is no need of balance control if the vehicle has at least three or in some case two wheels and wheeled locomotion is relatively power efficient, even at high speed, as figure 3 shows. The problems of wheeled robots are different from the problems of legged robots, as mentioned before, stability is not such a profoundly problem like it is in legged locomotion, but there are some others. The focus of research in wheeled robotics is on traction and stability in rough terrain, manoeuvrability and control.

3.1 Wheel types

The starting point of considering wheeled locomotion is the wheel itself.

In general there are four major classes of wheels as shown in figure 18 a) to d) [1].

Figure 18 a) shows the standard wheel with two degrees of freedom, these are rotation around the wheel axle and around the contact; Figure 18 b) shows the castor wheel with two degrees of freedom, rotation around the wheel axle and the offset steering joint; Figure 18 c) shows the Swedish 45° and Swedish 90° or omni wheel, which has three degrees of freedom: rotation around the contact point, around the wheel

axle and around the rollers; Figure 18 d) shows the Ball or spherical wheel, this wheel is omnidirectional, but it is technical difficult to implement.

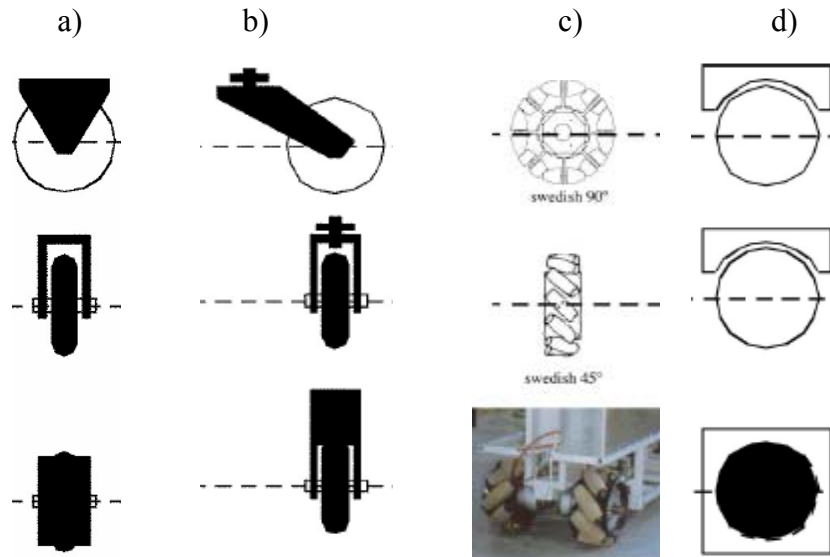

Figure 18: Four basic wheel types [1]

The main advantages of the standard and the castor wheel are the easy implementation, the high load capacity and the high tolerance to ground irregularities. But these wheels are not inherently omnidirectional, to make a vehicle using these wheels steerable, the steerable wheel(s) (depends on the wheel configuration of the vehicle) must be steered first along a vertical axis and the moved around a horizontal axis. So especially in case of heavy vehicles and when it is not moving during steering this steering method cause's high friction and scrubbing during steering as the wheel is actively twisted around its vertical axis, this increases the power consumption and reduces the positioning accuracy of the vehicle.

The Swedish wheel functions as a normal wheel, but it has little passive rollers around the circumference. These rollers provide low resistance in another direction as well, depending on the angle in which the rollers are arranged, so the wheel is able to roll smoothly in any direction. The wheels' primary axis serves as the only actively powered joint, but it is possible to design with these wheels holonomic omnidirectional robots; how this can be done is shown later.

The spherical wheel is a real omnidirectional wheel. There are several implementations of spherical wheels. One of this is the ball wheel mechanism which was developed by West and Asada in 1997 as shown in figure 19 [17,18].

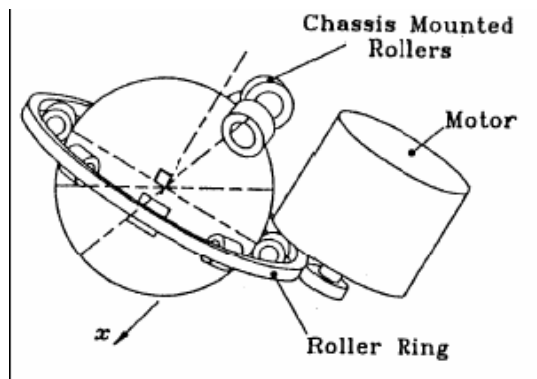

Figure 19: Ball wheel mechanism [17]

In the ball wheel design power from a motor is transmitted through gears to an active roller ring and then to the ball via friction between the rollers and the ball. Due to the rollers, fixed at the roller ring and the chassis, the ball is able to roll passively in any direction. A robot needs at least three spherical wheels to become mobile, as an example shows later.

When designing a wheeled robot, the developer has the choice of several different wheel arrangements and wheel types. The combination of wheel type and arrangement is strongly linked and governs the stability, manoeuvrability and controllability of the robot. One example of such a combination is the Ackermann wheel configuration of a car, with two steerable wheels in the front, two not steerable wheels in the rear; at least two wheels, connected by an axis, are motorized. Nearly every car uses this configuration, because it maximizes controllability, stability and manoeuvrability in the same shared environment: the roadway network. In case of mobile robots there is not just one environment where all robots are designed for, different robots are designed for applications in a wide variety of situations. But there is no single wheel configuration that maximizes controllability, stability and manoeuvrability qualities for every environment; in face of that the designer's task is to find a configuration that maximizes these qualities for the robot. Some examples of wheel configurations are shown later, but first the three issues of wheeled locomotion are considered more in depth.

3.2 Issues of wheeled locomotion

Stability

As mentioned before the minimum number of wheels required for static stability is two. A robot with a two wheeled differential drive can achieve stability if the centre of mass is below the wheel axle or if there is a third point of contact striking the floor. But these are some special cases; under normal circumstances a wheeled robot needs at least three wheels with ground contact to achieve static stability, additionally the centre of gravity has to be completely within the support polygon, formed by the three wheels with ground contact [1].

Manoeuvrability

Manoeuvrability is a very important issue for a wheeled robot to solve its tasks. When a robot is able to move in any direction of the ground plane (x,y) it is omnidirectional. This level of movement requires usually actively powered wheels that can move in more than one direction like Swedish or spherical wheels. In contrast the Ackermann steering configuration, which is used by cars, is not omnidirectional. Vehicles using this configuration have usually turning radius which are larger than the vehicle itself, furthermore it is not able to move sideways (that means in axis direction), such a movement requires several parking manoeuvres consisting of repeated changes in wheel direction and forward and backward movement. This steering method is very popular in hobby robotics, because it is relatively cheap to use a remote control race car kit as a robot platform which supports mobility [1].

Controllability

The advantage of omnidirectional designs is the high manoeuvrability of the robot, but this advantage makes it more difficult to control the robot. For example driving a robot which uses four powered Swedish wheels, like the Carnige Mellon Uranus robot (figure 23), straight forward, all wheels must be driven with exactly the same speed, to move in a perfectly straight line. Even little errors in the speed of the wheels will cause mistakes in the desired travel path of the robot.

At this point the benefit of Ackermann steering appears, because controlling such vehicles is much easier. Driving straight forward means just locking the steerable wheels and driving the motorized wheels. These are connected by an axis, so the speed of the drive wheels is always the same by actuating just one motor. After these considerations it can be said that there is in general an inverse correlation between controllability and manoeuvrability. If the vehicle is easy to control then it is less manoeuvrable; if it is high manoeuvrable, controlling is more difficult. [1]

3.3 Examples of wheel configurations

This chapter shows some different examples of wheel configurations.

The first example (figure 1) is the synchro drive [1] that is often used for indoor robots. This mechanism consists of three steerable wheels arranged in a triangle. All wheels are driven and connected by a single belt which is actuated by one motor, thereby this single motor sets the speed of all wheels together.

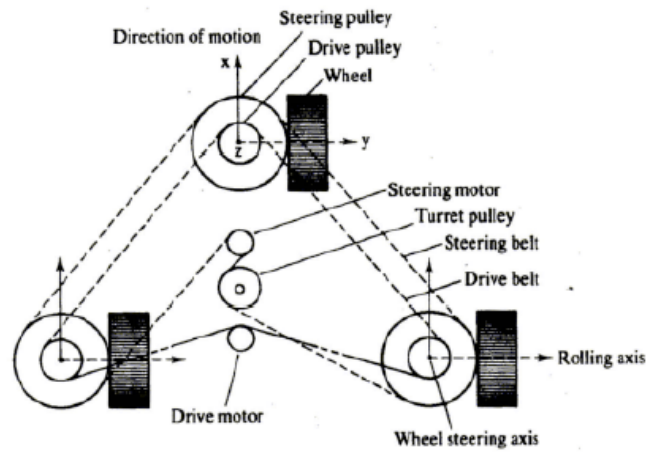

Figure 20: Synchro drive [1]

A second belt, which is actuated by an additional motor and is connected to the wheels too, is used to spin each wheel around its individual vertical axis. In this way the robot can be driven and steered relatively simple by controlling just two motors. One drawback of this method is that all wheels are steered with respect to the robots' chassis together, so there is no way to reorientate the chassis directly. Accordingly the robot is not really omnidirectional, since it is not able to rotate around its vertical axis. Another problem depends on the dead reckoning, because whenever the drive motor engages, the wheel which is closest to the motor begins spinning before the furthest wheel, this causes little changes in the orientation of the chassis, which accumulates to a large error in orientation when there are several changes in motor speed.

Real omnidirectional vehicles can be built by using castor, Swedish or spherical wheels. If the robot is able to move in an arbitrary direction out of any position at any time it is also holonomic. The following shows three examples of vehicles, using either three 90° or for 45° Swedish or three spherical wheels. Figure 21 shows Tribolo which was developed by the EPFL [1]. It uses three spherical wheels, each wheel is driven by one motor and has three contact points to the chassis. Two of them are spherical bearings and one of them is a wheel which is connected to the motor axis.

To rotate the robot around its vertical axis all motors are driven with the same speed; to drive the robot straight forward one motor has to be turned off and two motors have to be driven, one with velocity v and the other with velocity $-v$. The advantages of this design are the simple design and excellent manoeuvrability, but it is limited to flat surface and it is just capable to carry small loads.

Another approach to make a wheeled robot omnidirectional is the use of three or four Swedish wheels. Kovan robot (figure 22) [15], which was developed by the Kovan Research Lab², is an example of a robot which uses three actively powered Swedish 90° wheels.

² For more information see [15]

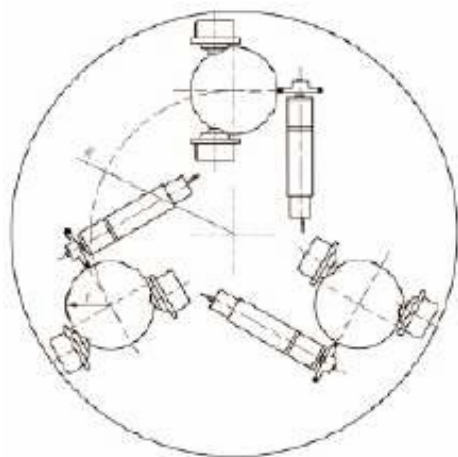

Figure 21: Tribolo which was designed at the Swiss Institute of Technology in Lausanne (EPFL) [1]

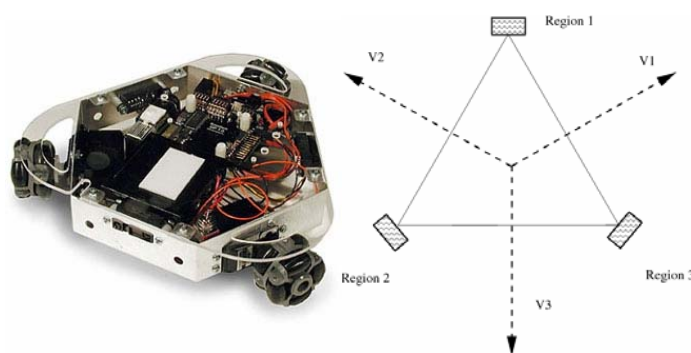

Figure 22: Kovan robot [15]

The robot is able to rotate in place by driving all wheels with the same velocity. Furthermore it is able to drive in the directions which are indicated by the arrows v_1 , v_2 and v_3 in figure 22 right. To make a linear movement in direction v_1 the first motor must move with velocity v , the third motor with velocity $-v$ and the second motor must be stopped, so that the second wheel will roll freely on the little rollers perpendicular to its powered axis of motion. So the steering of a robot using three Swedish 90° wheels is closely related to the steering of a robot using three omni wheels.

The Carnegie Mellon Uranus robot (figure 23) [1] is a third example of an omnidirectional robot. This robot uses four actively powered 45° Swedish wheels. To move the robot straight forward or backward all wheels must spin with the same velocity in the same direction. The robot is also able to do a lateral movement. To do this the diagonal pair of wheels must spin with the same velocity in the same direction (v) and the other diagonal pair of wheels must spin with same velocity in the opposite direction ($-v$). Furthermore the robot is able to rotate in place. To rotate clockwise the wheels on the left side must spin with velocity $-v$ and the wheels on the right side with velocity v (compare Figure 23 right).

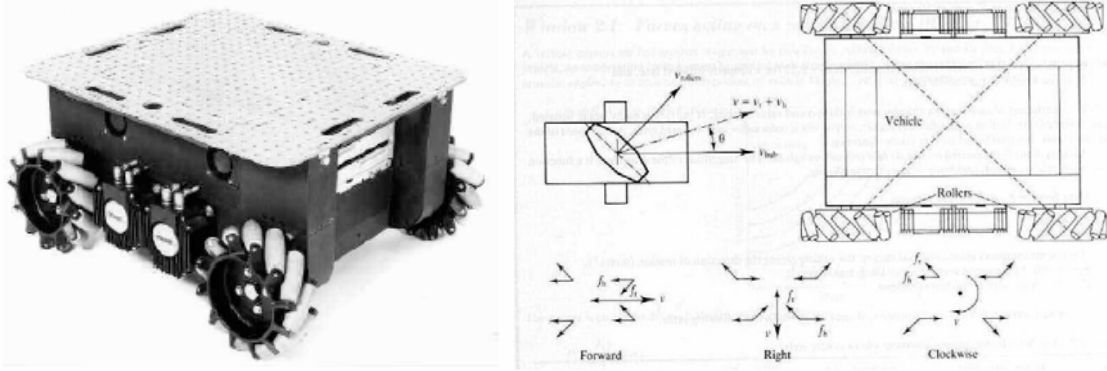

Figure 23: Carnegie Mellon Uranus robot [1]

4 Other concepts

Wheeled and legged locomotion are the most used and investigated locomotion mechanisms for mobile robots. But there are some other concepts, two of them are tracked slip/skid locomotion and a combination of wheeled and legged locomotion, which are the subjects of this chapter.

4.1 Tracked slip/skid locomotion

Wheeled locomotion offers some disadvantages, especially in case of omnidirectional vehicles using spherical or Swedish wheels, in rough, loose terrain, due to the increasing rolling friction which causes power inefficiencies as shown in figure 2.1; furthermore vehicles using wheels are just able to cross gaps that are smaller as the diameter of the vehicles wheels. In tracked slip/skid locomotion vehicles using tracks like a tank, one example of a robot using this concept is the Nanokhod robot (figure 24) [1] which probably will go to mars. A tracked vehicle is steered by moving the tracks with different speed in the same direction or in opposite direction.

The use of tracks offers a much larger area of ground contact, so the vehicles traction on loose surface is much better than the traction of wheels, furthermore the vehicle is able to drive through rougher terrain than wheeled vehicles are (it is for example able to cross larger gaps). Due to the large contact patches, tracked vehicles usually change their direction by skidding, where a large part of the vehicle slides against the ground, so the vehicle needs a lot of space to change the orientation of the chassis. The skidding movement has some other disadvantages which are coupled with the steering method itself and the surface. When the surface is hard (for example a tarred road) the vehicle is not able to slide against it, this increases the friction during steering and with this the power consumption of the vehicle. Furthermore the

exact change of the robot's chassis in position and orientation is hard to predict due to the sliding movement and changing ground friction.



Figure 24: Nanokhod, developed by Hoerner and Sulger GMBH and the Max Planck Institute [22]



Figure 25: Shrimp (EPFL) [21]

4.2 Walking wheels

Legged robots are able to climb stairs and travel through rough terrain, but they offer some inefficiencies on flat surface and controlling the robots is difficult. Wheeled robots are very energy efficient on hard surface, even at high speed, but most of them are surely not able to climb stairs. One idea is a hybrid solution which combines the advantages of legged and wheeled locomotion. Figure 25 shows shrimp [1], which was developed by the EPFL, a robot which uses 'walking wheels' to locomote. Shrimp has six motorized wheels and is capable to climb barriers that are two times larger than its wheel diameter. Shrimp has a steering wheel in the front and rear and two wheels arranged in a bogie at each side. Steering is realized by synchronizing the steering of the front and rear wheel and speed difference of the bogie wheels. This steering method allows high precision manoeuvres with a minimal skid movement of the four bogie wheels. One of the most interesting features of shrimp is that it is able to overcome obstacles passively, that means that the robot has no sensors to detect an obstacle, the robot's mechanical structure is able to adapt the profile of the terrain. Some interesting videos which are showing shrimp's abilities can be taken from [19].

Conclusion

After considering legged and wheeled locomotion in detail, within several different leg and wheel configurations and their advantages and disadvantages, it can be said that there is no superior locomotion mechanism, which is the best and the most usable in any situation. When developing a robot it is the

designer's task to analyze the terrain in which the robot will travel and what the robot has to do there. According to this analysis the robot's locomotion mechanism can be chosen. Due to this the application area of most robots is very specialized. For example a robot which is designed to serve in a hospital wouldn't work on the ground of a forest.

Furthermore there is, especially in legged locomotion, a large requirement of research, to make robots faster, more energy efficient, stable and manoeuvrable. As seen, there are a lot of commercial (like Sony and Honda) and non commercial (like several universities) research labs which spend lots of research energy in this thematic. So it will surely be interesting to consider the developments which are made in the next years.

References

- [1] S.Roland, *Introduction to autonomous mobile robots*, , pp. 12-45, 2004
- [2] M. Hardt, M. Stelzer, O. von Stryk, *Modellierung und Simulation der Dynamik des Laufens bei Roboter, Tier und Mensch*, Thema Forschung, Vol.2/2002, pp 56-63 ,2002
- [3] E. Cuevas, D. Zaldivar, R. Rojas, *Bipedal robot description*, Technical Report B 04-19, Fachbereich Mathematik und Informatik, Institut für Informatik, Freie Universität Berlin, 2004
- [4] M.H. Raibert, H. Brown, M. Chepponis, E. Hastings, J. Koechling, K.N. Murphy, S.S. Murthy, and A. Stentz, *Dynamically Stable Legged Locomotion*, Progress Report: October 1982 - October 1983, Robotics Institute of Carnegie Mellon University, pp. 1-11, 1983
- [5] <http://www.ai.mit.edu/projects/leglab/robots/robots.html>
- [6] <http://www.sony.net/SonyInfo/QRIO/technology/>
- [7] M. Vukobratovic, B. Borovac, *Zero Moment Point – Thirty five years of its life*, International Journal of Humanoid Robotics vol. 1, pp. 157–173, 2004
- [8] E. Cuevas, D. Zaldivar, R. Rojas , *Walking trajectory control of a biped robot*, Technical report, Freie Universität Berlin, 2004
- [9] http://www.ai.mit.edu/projects/leglab/robots/Spring_Flamingo/Spring_Flamingo.html
- [10] <http://www.sony.net/Products/aibo/>
- [11] C. Queiroz, N. Gonçalves, P. Menezes, *A Study on Static Gaits for a Four Legged Robot*, International Conference CONTROL'2000, 2000, Cambridge, UK
- [12] S. Cordes, K. Berns, *A Flexible Hardware Architecture for the Adaptive Control of Mobile Robots*, 3rd Symposium on Intelligent Robotic Systems '95, 1995
- [13] L.P. Kaelbling, L.M. Littman and A.W. Moore, *Reinforcement learning: a survey*, Journal of Artificial Intelligence Research, vol. 4, pp. 237–285, 1996
- [14] P.Maes, R. A. Brooks, *Learning to Coordinate Behaviors*, 8th National Conference on Artificial Intelligence, pp. 796-802, Boston, 1990
- [15] www.kovan.ceng.metu.edu.tr/index
- [16] R. Kurazume, K. Yonenda , *Forward and feedback dynamic trot gait control for quadruped walking vehicle*, International Conference on Robotics and Automation, 2001, pp. 3172 - 3180
- [17] H. Yu, S. Dubowsky, A. Skwersky, *Omni-Directional mobility using active split offset castors*, Journal of mechanical design, vol. 126, pp. 822-829
- [18] M. Wada, H.H. Asada, *Design and control of a variable footprint mechanism for holonomic omnidirectional vehicles and its application to wheelchairs*, Robotics and Automation, Volume: 15, pp. 978-989
- [19] <http://asl.epfl.ch/index.html?content=research/systems/Shrimp/shrimp.php>
- [20] <http://asimo.honda.com/>

[21] <http://asl.epfl.ch/research/systems/Shrimp/shrimp.php>

[22] <http://asl.epfl.ch/research/projects/FieldAndSpace/images/nanokhod.jpg>